

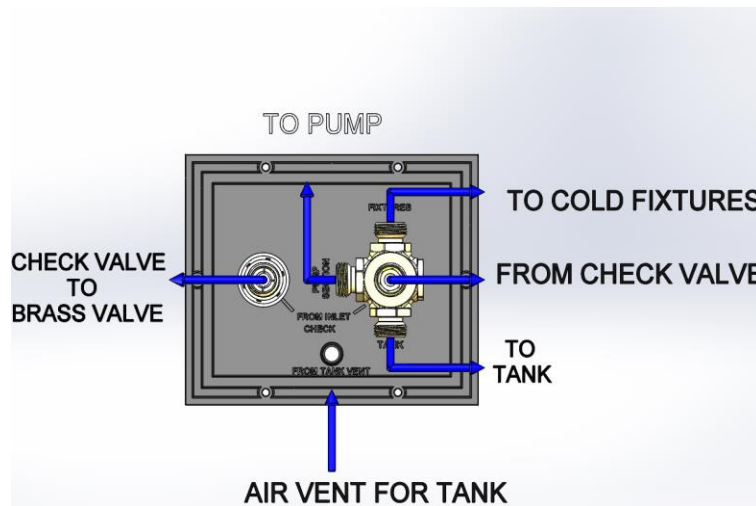

MANRV101 FLOW PATH

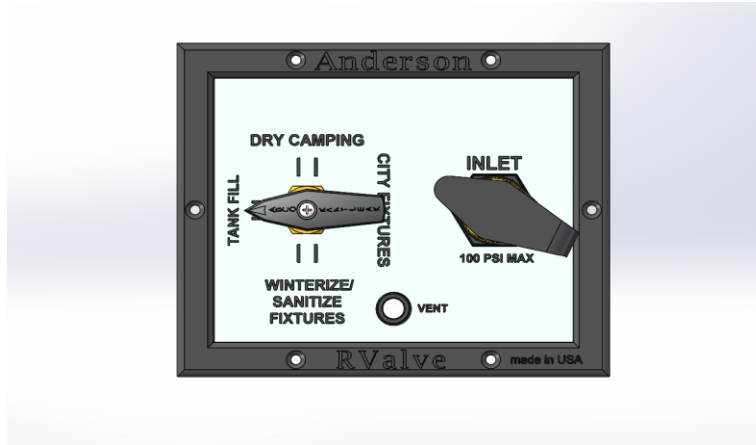

DRY CAMPING- TO RUN HOT AND COLD FIXTURES FROM STORAGE TANK (VIA RV PUMP)

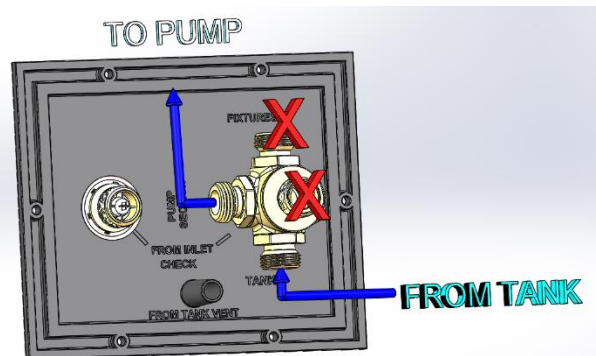
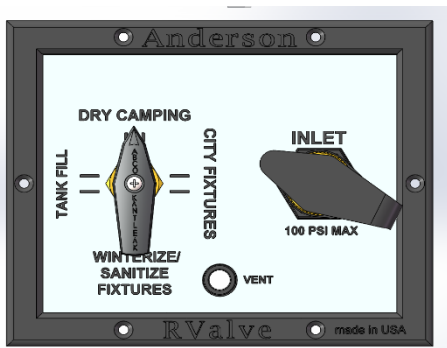

CITY FIXTURES- TO RUN FIXTURES FROM PRESSURIZED CITY WATER

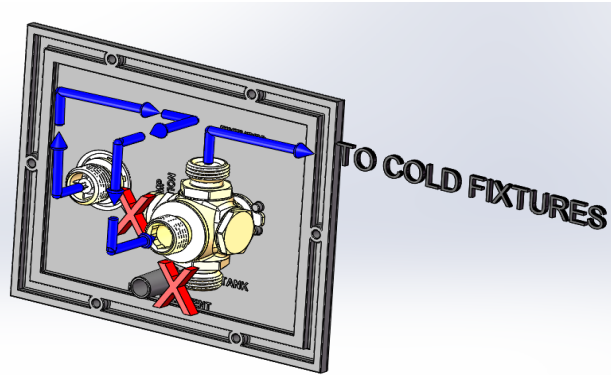
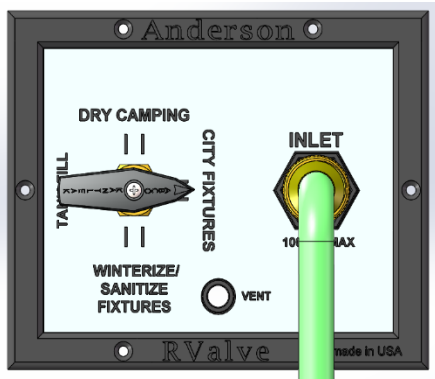

CITY FILL TANK- TO FILL STORAGE TANK FROM PRESSURIZED CITY WATER

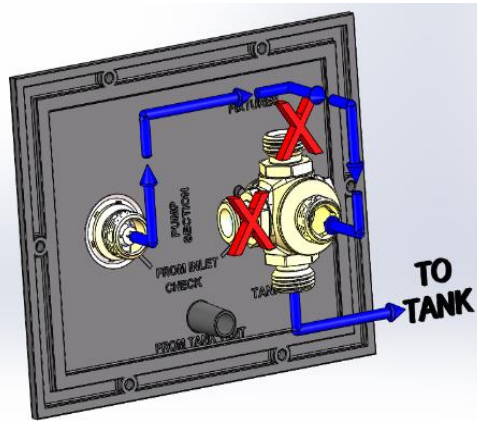
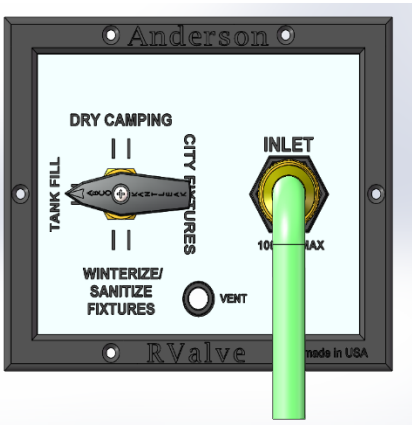

SANITIZE / WINTERIZE – TO SANITIZE / WINTERIZE FIXTURE (NOT TANK) FROM UNPRESSURIZED SOURCE

